



X100-ZDT

.....

Dedicated Z-Direction Tester based on the X100-1 Universal Testing Machine, for measuring internal bond strength of paper and board according to TAPPI T541 or ISO 15754. Featuring full computer control and precision AC servo drive system, the universal design allows the machine to be easily adapted for other test types (tensile, friction, flexural etc.) using Testometric's extensive range of grips and fixtures.

	X100-ZDT
Force Capacity kN	1
Accuracy	Better than +/- 0.5% of reading down to 1/1000th of load cell capacity
Included Load Cell	1000N (others available)
Included Fixtures	PBA-T541 fixture with set of 5 test blocks 1 inch or 25mm square (other sizes available)
Crosshead travel mm	420
Position Control Resolution mm	0.0001
Throat depth (force axis to column)	81
Minimum Speed mm/min	0.001
Maximum Speed mm/min	1000
Speed Accuracy	+/- 0.1% under stable conditions
Data Acquisition Rate (at PC)	500Hz
PC Connection	USB
Machine Configuration	Single-column, bench mounted
Frame Stiffness kN/mm	5
Weight kg	25
Operating Temperature °C	-10 to +40
Operating Humidity	+10 to +90% non-condensing
Electrical Supply	230V, 1ph 50/60Hz (115V option available)
Power kW	0.2

Made to measure



Fully digital testing system with high precision control and accuracy, includes automated computer control of test methods giving simplicity of operation.

High resolution load cells with accuracies better than +/-0.5% down to 1/1000th of the load cell capacity.

Automatic recognition of load cells and extensometers, with on-device storage of calibration parameters.

Software calibration check facility for instant verification of machine accuracy.

800% overload capability of load cells without damage.

High efficiency pre-loaded self cleaning ballscrews for fast, quiet testing. Fitted with sealed for life lubricated end bearings.

Crosshead guidance system providing precise alignment and smooth running.

Precision crosshead control via digital AC servo drive and brushless servo motor giving maintenance free operation and 20,000 pulses/rev positional control.

High speed data collection systems for up to 4 synchronous channels.

Expansion channel for additional devices such as extensometers, micrometers, calipers, balances etc.

High stiffness loading frames with solid specialised steel crossheads and rigid extruded support columns with T-slots for accessory mounting.

Overload, overtravel and impact protection.

Telescopic covers giving additional protection for ballscrews against dust and testing debris.

Small footprint design, giving economy of bench space.

Extensive range of grips and fixtures for tension, compression, flexural, shear, peel and product testing etc.

A wide range of contacting and non-contacting extensometers is available including laser and video models.

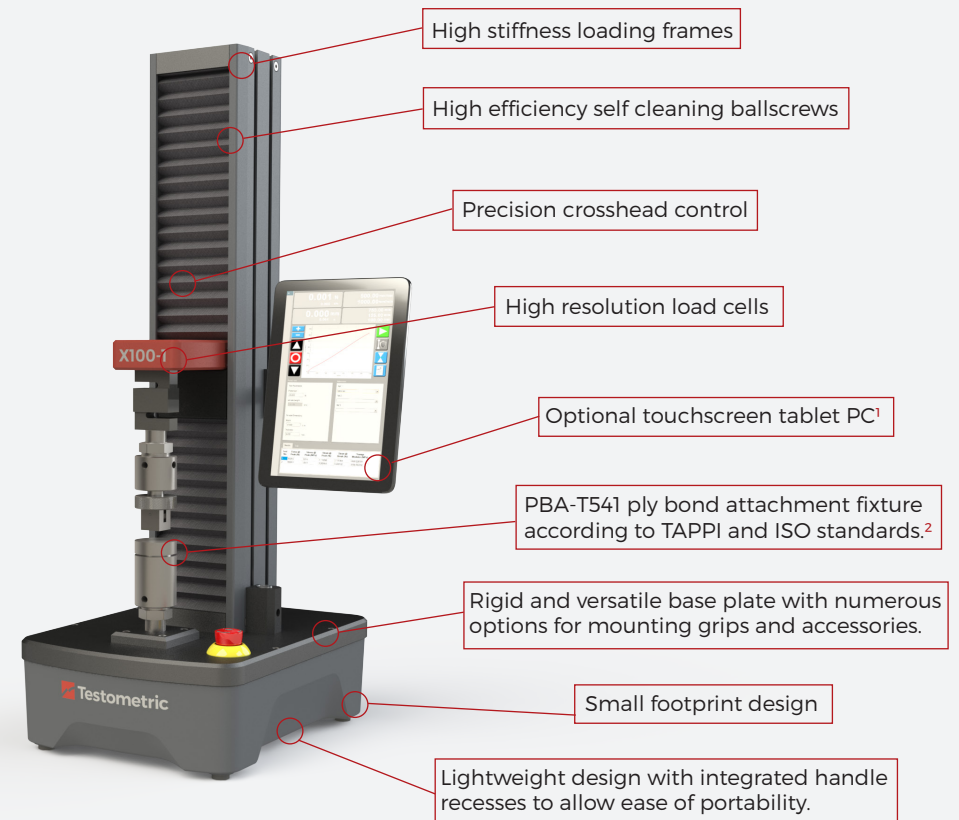

1. Available at additional cost. Machine can alternatively be controlled using a standard PC or laptop (not supplied).
 2. Universal mounting adaptor allows additional fixtures to be added for tensile, peel tests etc.

X100-ZDT Dimensions

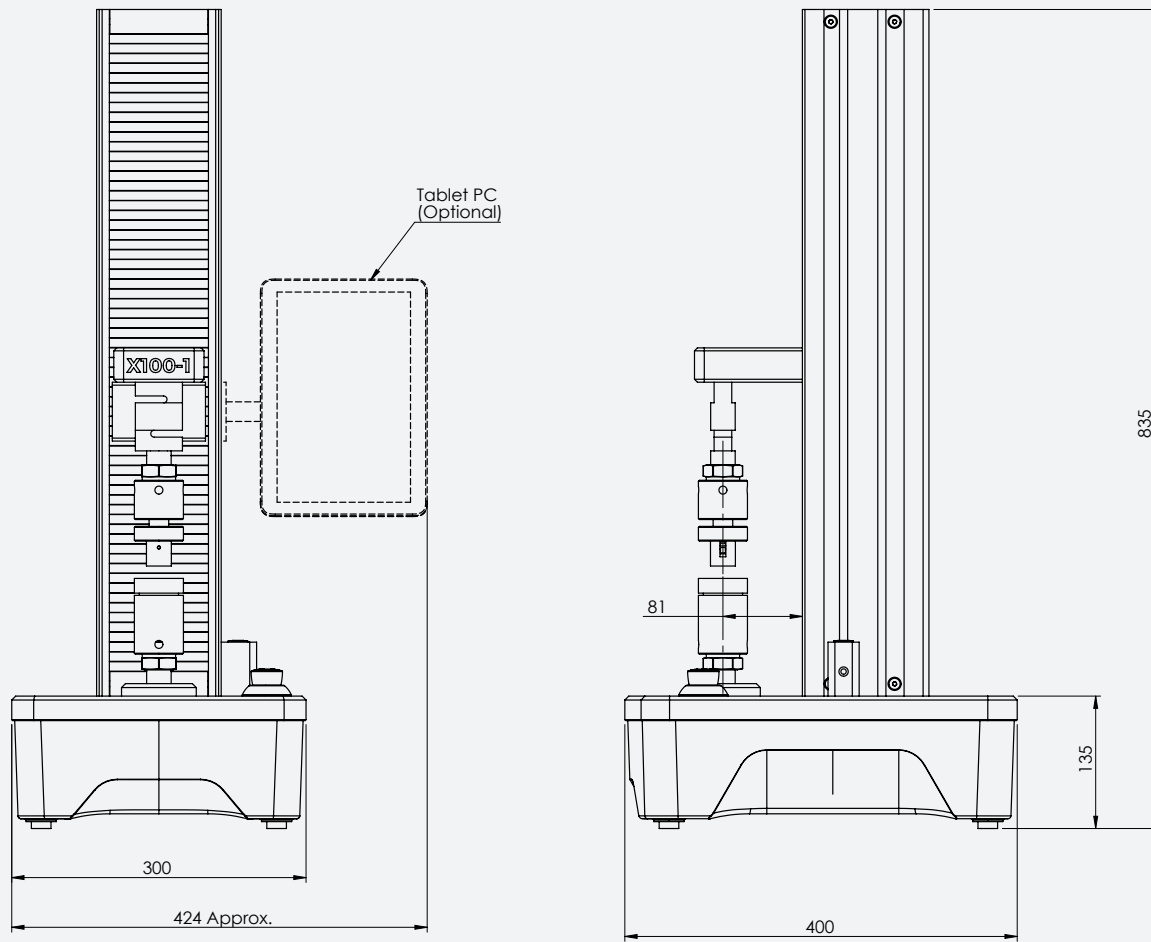

All dimensions in mm.

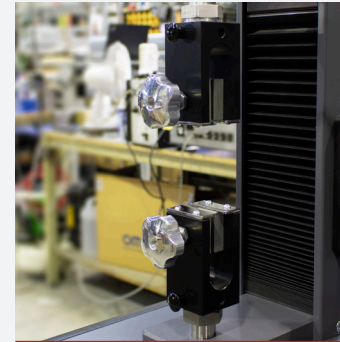

Large range of grips and fixtures including tensile, peel, tear and compression.

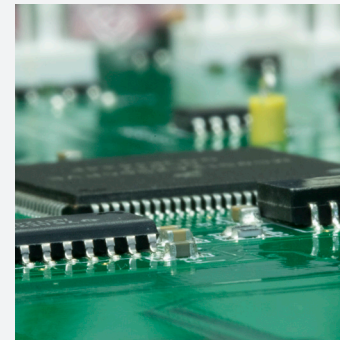

High-speed modular electronics

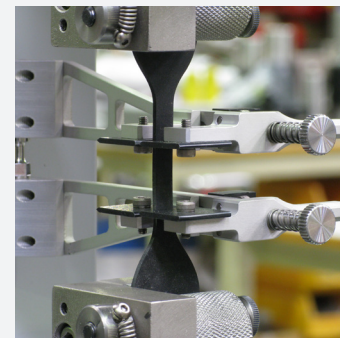

Comprehensive range of extensometry

Built for precision



Force Measurement

Universally Calibrated, better than Grade 0.5 EN 7500-1, DIN 51221 ASTM E-4, AFNOR A03-501. Range 0.4% to 100% minimum. Automatic identification of load cell. Resolution 1 part in 500000. Electronic load cell protection.

Extension Measurement

Full frame length to a maximum resolution of 0.0001mm (selectable). Accuracy +/- 0.01mm. Absolute, relative and auxiliary modes in mm, inch and percent.

Speed Control

Exceptional low speed performance with speeds down to 0.001mm/min. Drive system temperature and current protection.

Load Frame

Rigid frame, using precision linear guidance system and rigid extruded support column. Frame stiffness 5kN/mm plus K factor facility built-in. Re-circulating ball screw with bellows. Electronic limit trips, total travel trips and customer programmable safety stops.

Electronics System

Modular electronics system offers fast data transfer to the PC (500Hz) via high-speed USB connection. Extensive input options allow the connection of a wide range of extensometers and accessories via simple plug-in interface modules.

Safety Features

Extensive safety features to ensure highest levels of operator safety, including E-Stop, programmable extension limits and overload/impact detection. Fully compliant with global safety directives:- 2006/42/EU Machinery Directive, 2014/35/EU Low Voltage Directive and 2014/30/EU Electromagnetic Compatibility Directive.

Optional Tablet PC

When paired with the optional TPC1 tablet PC with touchscreen control, the machine becomes a robust standalone system without the need for an external PC or Laptop.

Using a specialised version of our WinTest software optimised for touchscreen operation, the system provides a fully-featured test environment with the ability to create and store unlimited methods and results. The included mounting arm which attaches to the machine column T-Slots is fully adjustable for height, reach and viewing angle allowing the user to find the most ergonomic working position.

The machine can alternatively be connected to a conventional desktop PC or laptop using our powerful WinTest EC software.



Tried and tested software



All Testometric models are supplied with our comprehensive winTest Analysis software package.

The product of many years of continuous development, winTest Analysis provides a flexible and intuitive software package to suit all types of material testing. With built-in test methods covering tensile, compression, flexural, peel, shear, tear, cyclic, creep and multi-stage tests.

It includes a wide range of industry standard test methods and the facility to create and store an unlimited number of further test methods. There is automated storage of all test data and ease of export to other software packages such as word, excel, access and SPC systems for enhanced report generation.

Please refer to the winTest software datasheet for further information.

With the addition of the RCE remote connection option all machines can be web-linked directly to Testometric for remote investigation, monitoring and software upgrades. Please refer to the RCE datasheet for more information.

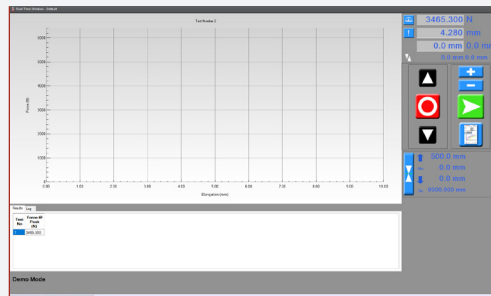

Real time test screen

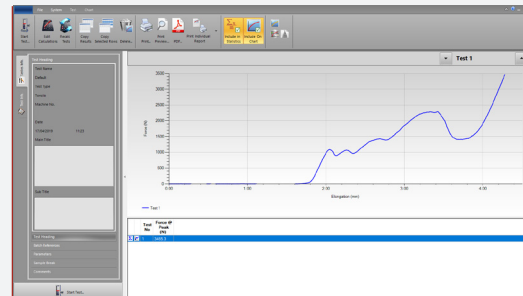

Test analysis screen



Standing the test of time



Testometric is a private limited company that has been involved in the design and manufacture of testing machines and quality control equipment since its foundation in 1970.

Fifty years of continuing development has resulted in a main product line of universal strength testing machines for tension, compression, flexure, shear and product testing. Testometric machines are used in over 100 countries worldwide and supported by a network of offices and approved agencies.

Testometric is established in all industries and educational sectors and we have an enviable reputation for innovation, product quality and excellent customer support.

testometric.co.uk